

ST150



概述/Descriptions

ST150 由一个红外发射二极管和一个 NPN 硅光电晶体管组成，

并排封装在黑色热塑性塑料外壳中的会聚光轴上。光电晶体管仅接收来自 IR 的辐射。

The ST150 consist of an infrared emitting diode and an NPN silicon phototransistor, encased side-by-side on converging optical axis in a black Thermoplastic housing The phototransistor receives radiation from the IR only .

产品特性/Features

- 可靠性高/High reliability
- 辐射强度高/High radiant intensity
- 低电压驱动/Low forward voltage
- 感应速度快/Fast response time
- 感光度强/High photo sensitivity
- 截止感应波长 940nm/Cut-off visible wavelength $\lambda_p=940\text{nm}$
- 无铅材料/Pb.Free
- RoHs 认证/RoHS compliant version

应用/Application

- 打印机、非接触开关/Printer、Non-contact Switching
- 智能电子产品/Intelligent Electronic Products
- 工业机械设备/Industrial Intelligent Equipment
- 安防防护应用/Safety Application Products

尺寸参数/Package Dimensions

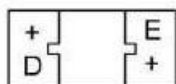
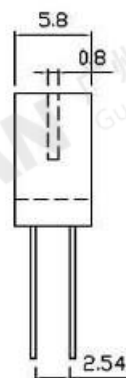
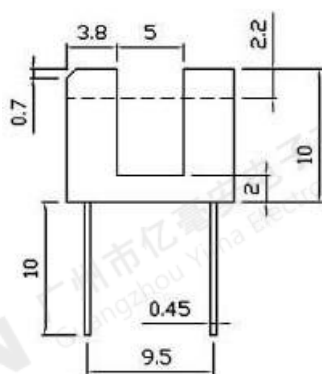
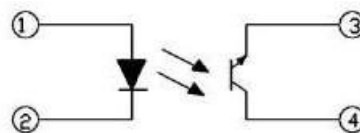
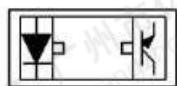

- | | |
|------------|--------------|
| ①: Cathode | ③: Collector |
| ②: Anode | ④: Emitter |

注：除非另有说明，否则公差为±0.1 mm 单位=mm
Note: Tolerances unless mentioned ±0.1mm. Unit = mm

最大限度参数值/Absolute Maximum Ratings (Ta=25°C)

参数名称 Parameter		符号 Symbol	最大额定值 Rating	单位 Unit
输入端 Input	消耗功率 Power Dissipation	P_d	75	mW
	反向电压 Reverse Voltage	V_R	5	V
	正向电流 Forward Current	I_F	50	mA
	脉冲正向电流 Peak Forward Current *1	I_{FP}	1	A
输出端 Output	集电极消耗功率 Collector Power Dissipation	P_c	75	mW
	集电极电流 Collector Current	I_c	20	mA
	集电极-发射极电压 Collector-Emitter Voltage	V_{CEO}	30	V
	发射极-集电极电压 Emitter-Collector Voltage	V_{ECO}	5	V
工作温度/Operating Temperature		T_{opr}	-25~+85	°C
储存温度/Storage Temperature		T_{stg}	-40~+85	°C
焊接温度/Lead Soldering Temperature *2		T_{sol}	260	°C

(*1) 脉宽少于等于 100us, 占空比 1%/ Pulse width \leq 100us, Duty cycle= 1%

(*2) 离胶体 2mm 以上焊接 5s 内/ 2mm form body for 5 seconds

主要光电参数/Electro-Optical Characteristics

参数名称 Parameter		符号 Symbol	最小值 Min.	标准值 Typ.	最大值 Max.	单位 Unit	条件 Conditions
输入端 Input	正向电压 Forward Voltage	V_F	----	1.2	1.5	V	$I_F=20mA$
	反向电流 Reverse Current	I_R	----	----	10	μA	$V_R=5V$
	峰值波长 Peak Wavelength	λ_P	----	940	----	nm	$I_F=20mA$
输出端 Output	集电极暗电流 Collector Dark Current	I_{CEO}	----	----	100	nA	$V_{CE}=10V, E_e=0mW/cm^2$
	集电极-发射极工作电压 C-E Saturation Voltage	$V_{CE(sat)}$	----	----	0.4	V	$I_C=0.5mA, E_e=1mW/cm^2$
转换特性 Transfer Characteristics	集电极光电流 Collect Current	$I_c(ON)$	0.5	10.0	----	mA	$V_{CE}=5V, I_F=20mA$
	上升时间 Rise time	t_r	----	15	----	μsec	$V_{CE}=5V$
	下降时间 Fall time	t_f	----	15	----	μsec	$I_C=1mA$ $R_L=1K \Omega$

发射管特性曲线图/Typical Electrical/Optical/Characteristics Curves for IR

Fig.1 Forward Current vs. Ambient Temperature

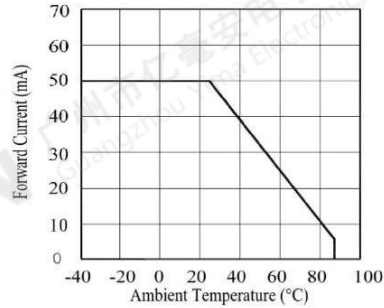

Fig.2 Spectral Distribution

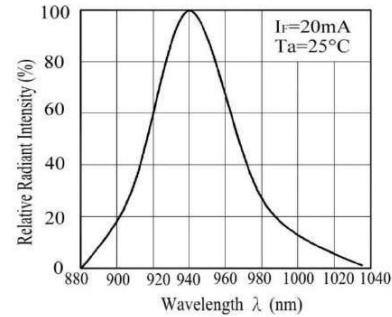

Fig.3 Forward Current vs. Forward Voltage

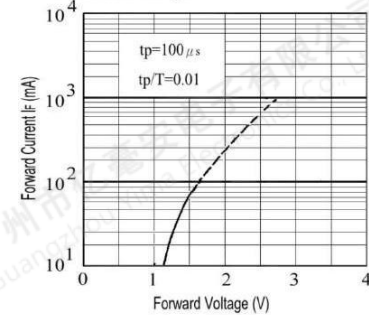
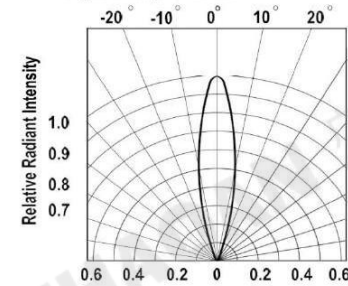

Fig.4 Relative Radiant Intensity vs. Angular Displacement



接收管特性曲线图/Typical Electrical/Optical/Characteristics Curves for PT

Fig.1 Spectral Sensitivity

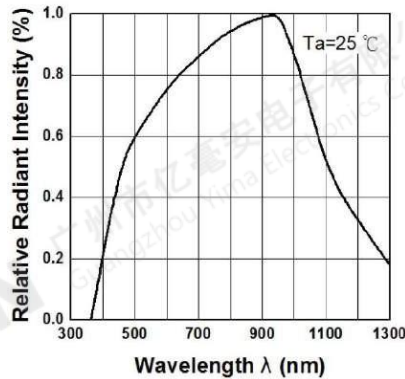

Fig.2 Collector Current vs. Irradiance

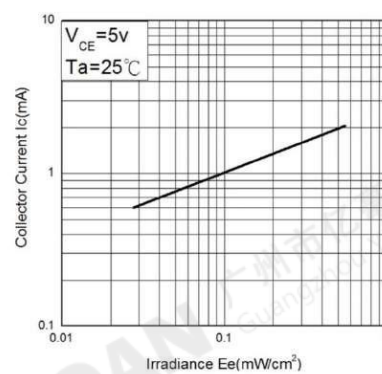
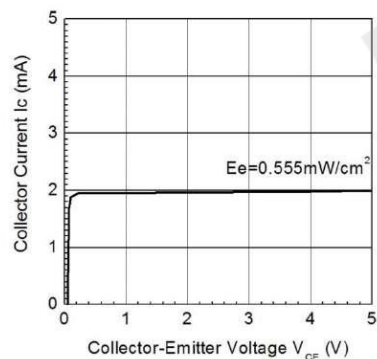

Fig.3 Collector Current vs. Collector-Emitter Voltage



标签标识/Moisture Resistant Packing Materials



CAT: Ranks
HUE: Peak Wavelength
REF: Reference
QTY: Packing Quantity
LOT No: Lot Number

包装规格/Packing Specification

最小包装/ Packing : 200 pcs/ bag

注意事项/Notes

设计指南 Design Guide

1、避免检测失败 Prevention of detection error

为了防止外部光引起的光中断器故障操作，不要将检测面设置为外部光

To prevent photo interrupter from faulty operation caused by external light, do not set the detecting face to the external light.

2、检测板的位置 Position of opaque board

检测板应安装在距元件顶部 1.6mm 或以上的地方

Opaque board shall be installed at place 1.6mm or more from the top of elements.

衰减状况 Degradation

一般情况下，光中断器中使用的 IRED 的发射会随着时间的推移而降低。在长期运行的情况下，请将一般的发射管衰解（5 年内衰解 50%）纳入设计考虑。

In general, the emission of the IRED used in photo interrupter will degrade over time. In the case of long term operation, please take the general IRED degradation (50% degradation over 5 years) into the design consideration.

开封后的储存和管理 Storage and management after open

1、储存条件 Storage condition

储存温度在 5 至 30°C，储存湿度 70%RH 或以下的常规包装

Storage temp.: 5 to 30°C, Storage humidity : 70%RH or less at regular packaging.

2、打开防潮包装后处理 Treatment after opening the moisture-proof package

打开后，您应该在 4 天内安装产品，同时保持在 5 至 25°C 和 70%RH 或湿度较小的条件下。

After opening, you should mount the products while keeping them on the condition of 5 to 25°C and 70%RH or less in humidity within 4 days.

3、一旦打开袋子，必须按照要求进行延长储存，建议产品两周内安装完产品。

After opening the bag once even if the prolonged storage is necessary, suggest installing the product within two weeks.

4、当你储存其余的产品时，你应该把它放进一个干燥的盒子里。否则以后其余产品硅胶再次密封，你应该保持在 5 至 30°C 和 70%RH 或条件下湿度较小。

And when you store the rest of products you should put into a DRY BOX. Otherwise after the rest of products and silicagel are sealed up again, you should keep them under the condition of 5 to 30°C and 70%RH or less in humidity.

5、当上述储存方法无法执行时，请在安装产品之前进行烘焙处理。When the above-mentioned storage method could not be executed, please process the baking treatment before mounting the products.

6、然而，烘焙处理是允许在一次内。推荐条件：125°C，16 至 24 小时 However the baking treatment is permitted within one time. Recommended condition : 125°C, 16 to 24 hours.

7、不要将产品包装一起加工烘焙处理。烘焙处理时，应将产品移至金属托盘或将产品临时固定在基板上。

Do not process the baking treatment with the product wrapped. When the baking treatment processing, you should move the products to a metallic tray or fix temporarily the products to substrate.

焊接方法 Soldering Method

1、回流焊接应遵循下面所示的温度剖面。焊接不应超过温度剖面和时间曲线。请在一次内焊锡

Reflow soldering should follow the temperature profile shown below. Soldering should not exceed the curve of temperature profile and time. Please solder within one time.

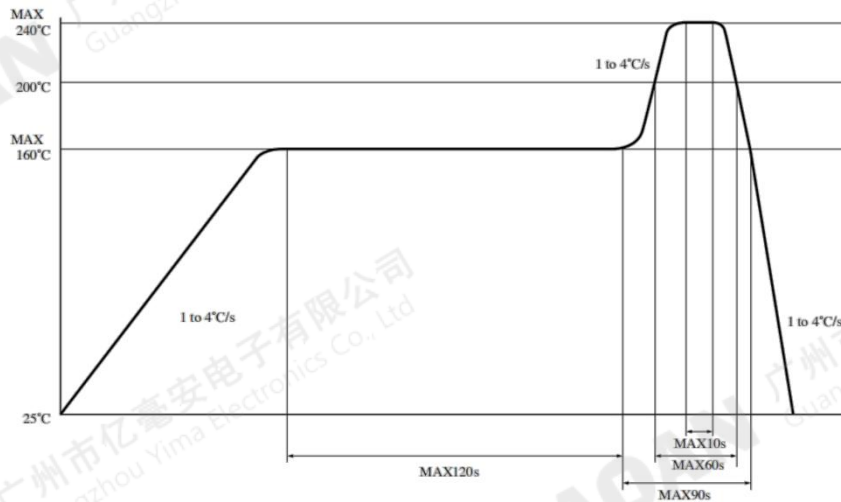

2、当焊锡铁点低于 350 时，手工焊接应在 3s 内完成。请在一次内焊接。请不要直接用烙铁触摸端子。灭菌产品应在常温下处理。

Hand soldering should be completed within 3 s when the point of solder iron is below 350°C. Please solder within one time. Please don't touch the terminals directly by soldering iron. Soldered product shall treat at normal temperature.

3、请注意不要让任何外力施加在引脚上。请在实际情况下测试焊接方法，并确保焊接工作良好，因为对器件和 PCB 之间的连接的影响取决于冷却和焊接条件。

Please take care not to let any external force exert on lead pins. Please test the soldering method in actual condition and make sure the soldering works fine, since the impact on the junction between the device and PCB varies depending on the cooling and soldering conditions.

4、本产品的引线端子为镀锡铜合金。在使用前，请评估确认可焊性的实际条件。并且没有指定引线端子的颜色均匀性。

Lead terminals of this product are tin copper alloy plated. Before usage, please evaluate solder ability with actual conditions and confirm. And the uniformity in color for the lead terminals are not specified.

清洁说明 Cleaning instructions

1、溶剂温度应在 45° C 或以下。浸泡时间应在 3 分钟或以下。

Solvent temperature should be 45° C or below. Immersion time should be 3 minutes or less.

2、不执行超声波清洗。

Do not execute ultrasonic cleaning.

3、推荐溶剂材料：乙醇、甲醇和异丙醇

Recommended solvent materials :Ethyl alcohol, Methyl alcohol and Isopropyl alcohol.