



Surface Mount Chip LED Product Packing

1206 SMD LED

Spec No.:

Created Date: 2015/08/17

EHAOAN Electronics Co., Ltd.

Shiqiaodong Ring Road Port Xincheng Building, Panyu District, Guangzhou

Tel:020-39175575 Email: led@ehaoan.com

<http://www.ehaoan.com>

Package Dimensions/尺寸參數

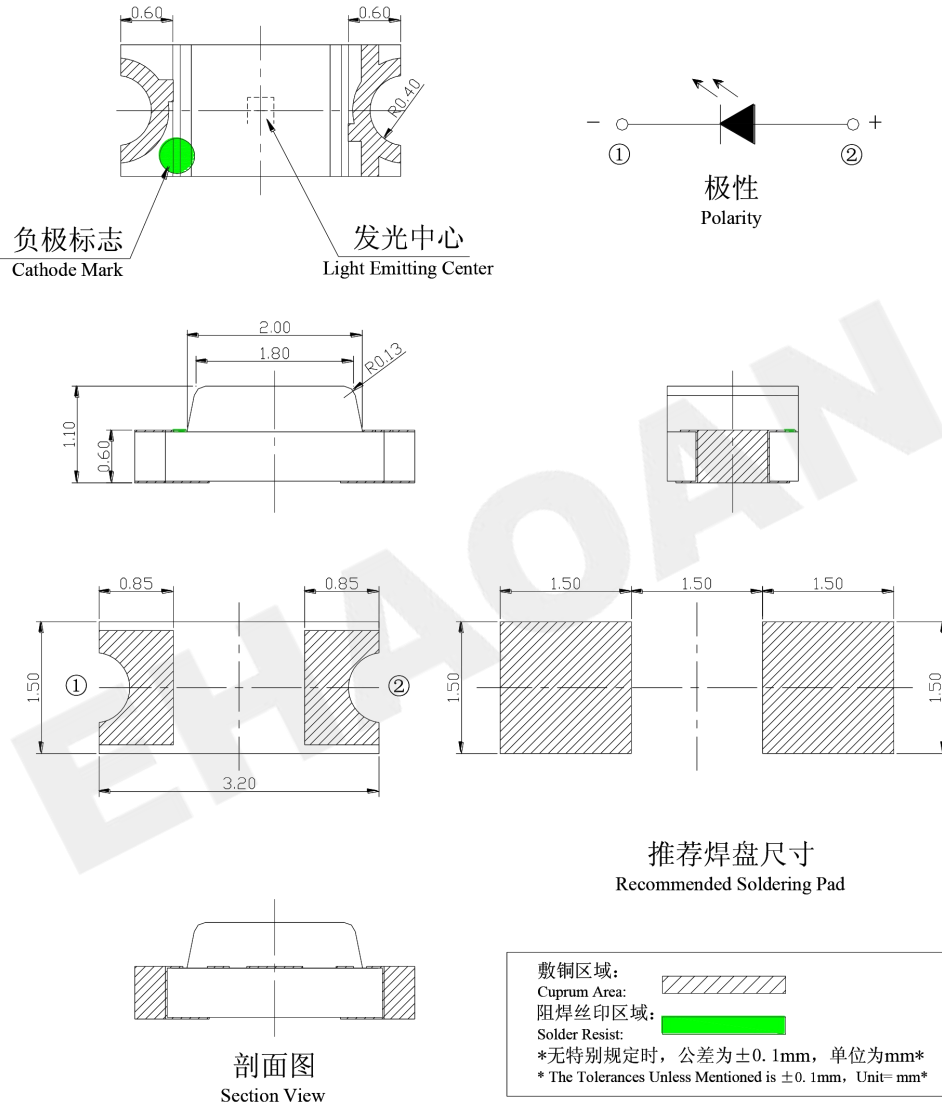

Note: Tolerances unless mentioned ±0.1mm. Unit = mm

註：除非另有說明，否則公差為±0.1 mm 單位=mm

Moisture Resistant Packing Materials/標籤標識

- CAT: Luminous Intensity Rank (unit : mcd)
- HUE: Dominant Wavelength Rank (unit : nm)
- REF: Forward Voltage Rank (unit : V)
- Rank Tolerance:
 - a. Luminous Intensity: $\pm 15\%$
 - b. HUE: $\pm 1\text{nm}$
 - c. Forward Voltage: $\pm 0.1\text{V}$

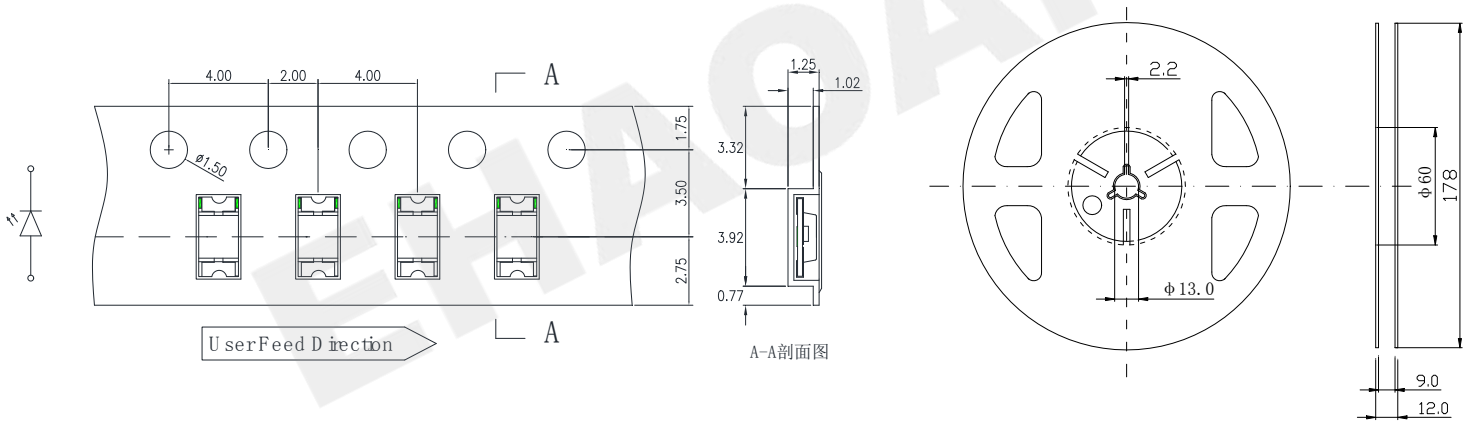
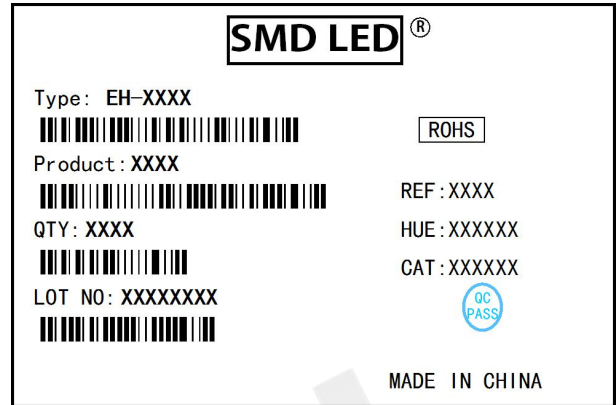

Note: The tolerances unless mentioned is $\pm 0.15\text{mm}$, Unit = mm

註：除非另有說明，否則公差為 $\pm 0.15\text{mm}$ 單位=mm

